

Warnings

The Lowel Omni-lights are professional lighting fixtures. Read these instructions and lamp manufacturer's warnings fully before operating.

- **Not for household use**, use only for film, video or imaging purposes.
- **Do not leave lit fixture unattended.**
- **Unplug lights when unattended** or when relamping.
- **Make certain that lamp voltage matches** power source voltage. The unit uses lamps of different voltages (example: never connect a 120 volt lamp to a 220/240 volt source).
- **Lights such as these emit considerable light and heat** and, if not properly used, could be dangerous.
- **The Protective Screen must be used** to protect people and property in the unlikely event of a defective lamp exploding.
- **Open faced lights should not be** positioned extremely

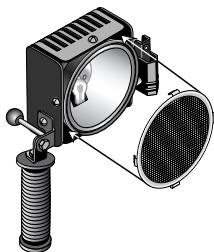

close to people. Ultraviolet light ray emissions can cause damage to the eyes and reddening of the skin. The likelihood of either occurring is increased with length of exposure, focus intensity and proximity. Therefore, lights should be kept away from people or a dichroic, frosted glass, or clear glass should be used. Bounce illumination also reduces this problem.

- **Avoid aiming the light at**, or placing close to, people, delicate objects or flammable materials.
- **Do not interfere with ventilation** by covering the lights in any way.
- **Never touch hot parts.**
- **Do not use near standing water.**
- **Lights should be operated with lamp filament horizontal.**

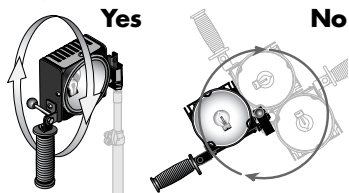

- **Avoid mounting lights directly** over people unless secured with a safety cord or cable.
- **Do not focus Omni to spot** when using with umbrella accessory.



Technical Data

Weight less cable: 1.7 lbs (771 g)
With 16' cable: 2.6 lbs
Max. wattage: 500w at 120v and 220/240v
Max. amperage: 8.3 at 30v & 12v
Beam control: continuously variable
Fits on: studs 5/8" (1.59 mm) and smaller
Materials: primarily aluminum alloy
Cable: 12, 120, 220, 240v: 16' #18/3 wire; 30v: 5' #18/3 wire
Switch: in-line
U.S. Patent: 4187531

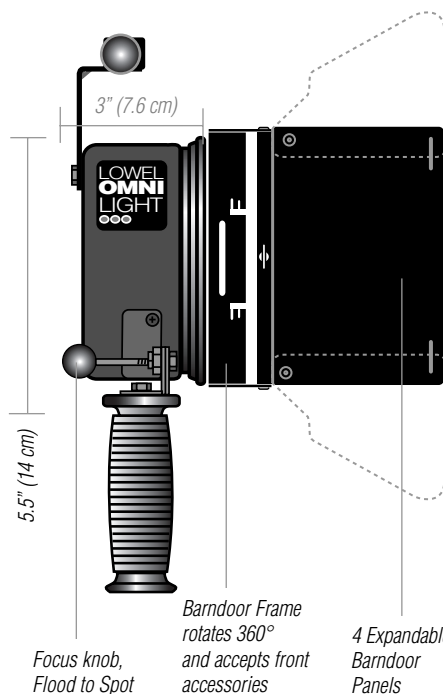
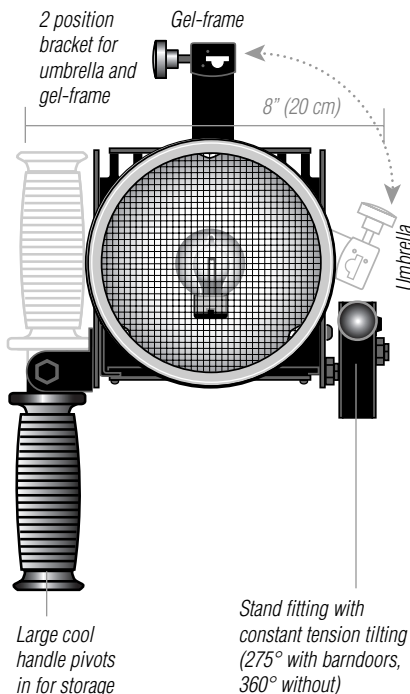

Lamp/Beam Data

Lamp Code	Volts	Watts	°K	Avg Life	Foot Candles at 10' (3 m), w/prot. screen		
					Flood	Spot	Focus Range Super Spot
EYL	12	100	3200	50 hr	14 (150)	111 (1200)	8:1 242 (2600)
DYG	30	250	3400	15 hr	37 (400)	311 (3350)	8:1 753 (8100)
JCD120V/300WC							
	120	300	3200	70 hr	32 (345)	278 (3000)	9:1 444 (4800)
EKB	120	420	3200	75 hr	66 (715)	390 (4200)	6:1 753 (8100)
FTK	120	500	3200	100 hr	75 (810)	475 (5130)	6:1 920 (9936)
JCD230V-300WC							
	230	300	3200	75 hr	27 (290)	222 (2400)	8:1 361 (3900)
JCD240V-500WC							
	240	500	3200	50 hr	47 (510)	370 (4000)	8:1 833 (9000)

Performance

With 120v, 500w, 3200°K, FTK lamp

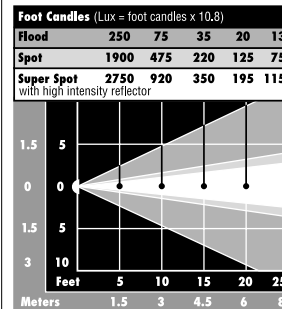

Beam angles—points at which intensity drops to 50% of maximum

Omni Lamps Replacement

Always unplug unit before relamping. Lamps must be operated at their rated voltage. Avoid touching "glass" with bare fingers. Insert lamp carefully, to avoid breaking. Due to inconsistencies in lamp (bulb) production, an individual lamp may function for more or less than its average rated life. Some lamp manufactures are of better quality than others and may provide longer life and better performance. Lamps may be changed with reflectors installed or removed.

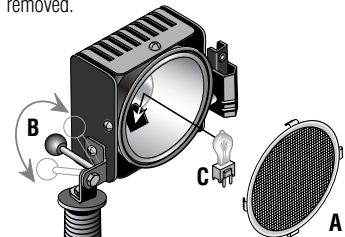

- A Remove safety screen
- B Hold focus knob in spot position
- C Rock lamp gently from side to side while lifting from socket.

The electrical contacts of the Omni lamp socket are very "stiff" and require considerable lamp insertion pressure to properly seat the lamp. **If the lamp is not fully inserted, it can cause arcing and pitting of both the socket and lamp pins reducing both lamp and socket life.** Replace safety screen. Never operate light without Protective Screen, metal scrim or safety glass accessory. We suggest that you do not remove the lamp from the fixture when transporting the light, locally.

Omni Operations

To Store Omni

When fixture is cool to the touch, disconnect plug on rear of light, swing handle up, swing gel-brella bracket down, rotate stand fitting up 45°. Swing in extending flaps on large doors and "square" barn-door with unit. It is not necessary to remove barndoor or flaps.

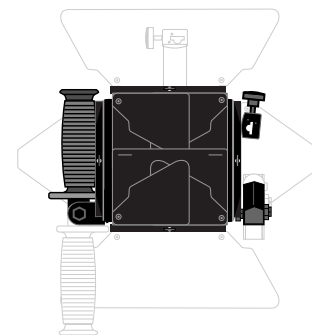



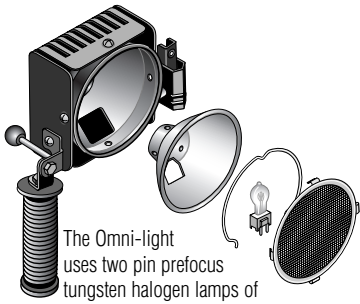

Lowel Omni-light Instructions

Omni Light Controls

Omni Reflectors



The Omni-light uses two pin prefocus tungsten halogen lamps of different voltages and filament configurations. To solve the optical problems most efficiently, the fixture has two different standard focusing reflectors. In addition two special purpose reflectors are also available. For identification each has a number embossed on the reflector.

-  **#1** Standard focusing reflector: for all 120 and 240 volt lamps.
-  **#2** Standard focusing reflector: for 12 and 30 volt lamps. May also be used for 120 and 240 volt use providing a slightly smoother pattern but with reduced output and focusing range.
-  **#3** High intensity, super spot: long "throw," non-focusing reflector for all voltages.
-  **#4** Gold focusing reflector: creates warm color effects for use with all voltages.

Changing Omni Reflectors

When fixture is cool to the touch. Disconnect plug on rear of light. Remove Protective Screen then remove reflector retaining spring by first pulling either end of spring inward. Focus lamp to spot position and tilt Omni-light down slightly. Reflector can be lifted around the lamp. To install reflector, tilt Omni-light up, keep lamp focused to spot, insert reflector around lamp and onto registration pin. Replace reflector spring and Protective Screen. **Never operate light without Protective Screen.**

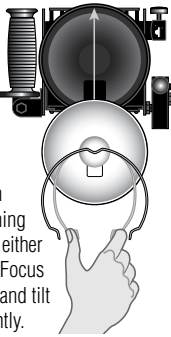

Omni Barndoor

Barndoor frame snaps onto rim on front of light. It can be removed by pushing out on two adjacent sides while pulling that corner forward. The frame holds any two accessories, rotates 360° and joins two snoots.

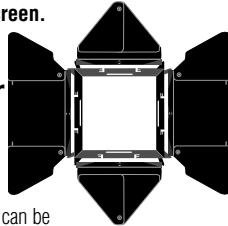

Large door has two extending wings which stop in open position, this stop may be bypassed.



The Triangular door has two extending wings to increase their area or create special shadowing effects.

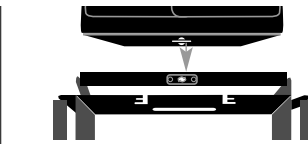

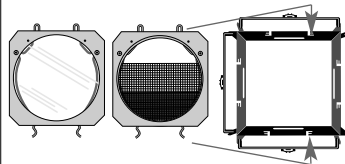

The Locking Fastener requires 1/4 turn to remove or install doors. If barndoor frame fails to maintain proper tension on light, the frame should be removed and squeezed inward, very slightly.

Omni Barndoor Accessories



Each barndoor frame can hold any two barndoor accessories. Handles on the accessories are sprung together to insert or remove accessory. First accessory used should be positioned in rear slots. Second accessory or snoot can then be used in forward slots. **When a wire scrim and glass accessory are used simultaneously, the wire scrim should be placed closest to the lamp, to reduce the possibility of glass breakage.**

-  **Full scrim:** reduces light intensity by approximately 50%.
-  **Half scrim:** covers half of reflector and rotates 360°. Darkens washed out foregrounds, compensates for talent "burning up" as they approach a light.

 **Graduated scrim:** same principle as half scrim but effect is more gradual and more extreme.

 **Dichroic filter:** converts 3200K lamps to average daylight; absorbs U.V. light rays Light loss approximately 65%.

 **Clear glass filter:** absorbs U.V. light rays. Light loss approximately 5%.

 **Diffused glass:** softens highlights and shadows. Absorbs U.V. light rays Light loss approximately 40% in flood setting.

 **Cookaloris:** produces an overall, soft shadow pattern, can be used to "breakup" a plain background.

Snoot: produces a reduced circle of light; two Snoots may be joined with an additional barndoor frame to produce a smaller and sharper circle of light. Barndoors and barndoor accessories may also be added to the end of the Snoot.

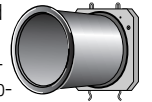

Narrow Snoot: produces smaller diameter circular cutoff (2.25" diameter). Accepts Fren-L patterns as well as Pro-light barn doors & swing-in accessories.

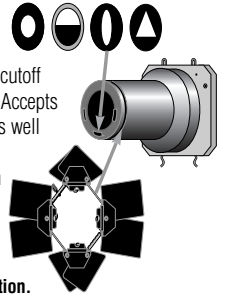

See www.lowel.com for more information.

The following components are shared by both the Tota and Omni-lights. Their attachment may differ slightly between Tota and Omni, see Tota instructions for more information.

Umbrellas

Photographic umbrellas convert relatively hard light sources, such as spotlights, into relatively soft sources that provide soft shadows and highlights. Although not appropriate for every subject or mood, the quality of light can be very beautiful. There are two Umbrellas designed for use with the Omni-light, a woven, soft silver Tota-brella (T1-25) and a softer white Tota-brella (T1-26)



that produces a softer light and also may be used as a large diffuser.

Warning: When using umbrella with Omni, do not focus light to spot.

Warning: When lights with umbrellas are extended very high, or used on undersized stands or in areas of heavy "traffic", it is advisable to add weight (such as the Lowel weight) to the base of the stand. This reduces the chance of lights falling over which could damage the umbrella, the lamp, and possibly cause personal injury.

Using Umbrellas

Remove entire barndoor (or just the four flaps if an accessory such as a dichroic filter is used). Set gel-brella bracket to umbrella position (line up arrow guides on back panel). Insert umbrella through hole until shaft appears through opposite hole.

Do not position umbrella further into the fixture than the automatic stop (clip) allows, or scorching may occur. Lock with knob. For best soft-light effect, focus Omni to full flood position. To prevent damage to umbrella, do not focus to spot or half-spot position as scorching of the umbrella may occur. Since the gel frame cannot be attached when the umbrella is inserted, the dichroic filter should be used for daylight correction. When using the DP Umbrella the tilt tension of the light may have to be increased. This can be done easily by tightening the nut located on the stand fitting with a 7/16" wrench. Do not over tighten!

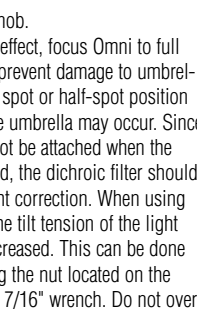
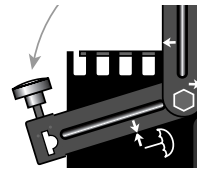

Tota-frame

Set Gel-brella bracket in gel frame position (line up guides on back panel). Unfold frame, extending frame bar and insert through front hole of gel-brella holder until shaft appears through opposite hole. Lock with knob.

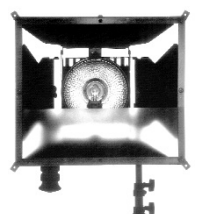
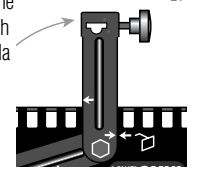

Tota/Omni Shared Light Control Accessories

Tota/Omni Shared Light Control Accessories Continued

Tota/Omni Gels

Gels are secured to the frame with corner spring clips. Gels should not be doubled up. Precut, tough, fade resistant Lowel gels are available in daylight blue, frost diffusion, & neutral density. When gels are used, the Omni should not be spotted-down excessively. (See gel instruction sheet.)

Tota-flag & Tota-flector

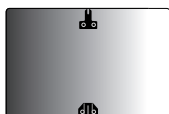
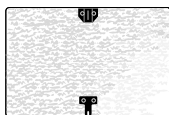
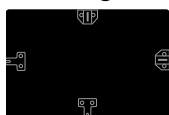

Tota flags can be used separately, or snapped together end to end or side to side. Flags can be attached to the light with a flexi-shaft. Flags block or "feather" light off background, subject, or camera lens. Tota-flectors can be attached in the same way and used to redirect some of the light. It can also provide close-up fill illumination from

the sun or other source over a small area. Slight convex bowing of the surface will reduce the intensity and increase the area illumination. Avoid mounting flags or reflectors directly over people unless secured with a safety cord or cable.

Flexi-shaft

A flexible arm to position Tota-flags and Tota-flectors. Its fixed end snaps into a female connector on the Tota & Omni-lights, Tota-clamp and other Tota components. The rotating end snaps on to the flag, flector etc. Avoid overstressing connectors while bending and twisting.



Tota-tatch

Spring clamp attaches Tota-flags and Tota-flectors with or without Flexi-shafts, to stands, pipes, and flat surfaces. The snap-in fitting rotates to help position flags, cards etc.



Gel-jawz attach to barndoor leaves to hold gels.



Omni Power Cords

16' Tota/Omni Cable

Code: T1-80

Standard #18/3; with switch & standard Edison wall plug.

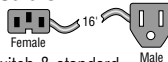

16' (5 m) Tota Eurocord

Code: T1-801

#18/3 (.75 mm/3) with double pole switch and male CEE-7 plug.

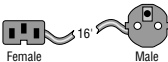

16' (5 m) Tota UK Cord

Code: T1-802

#18/3 (.75 mm/3) with double pole switch and male fused BS 1363A plug.

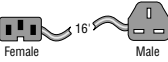

5' Omni 30v Cable

Code: O1-81

#18/3; with switch and 2 pin "Amphenol Type" connector for batteries.

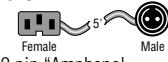

Omni 12v Car Adaptor

Code: O1-82

Connects T1-80 Cable to cigarette lighter connector.



10' Unswitched Cable

Code: T1-808

For portable stage lighting use. "Hard service" #18/3 cable.

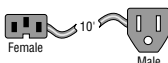

Mounts

Omni-stand

Code: O1-33

Weight: 2.6 lbs (1.2 kg)

Size: (2.74 m), 27" (69 cm) folded
Sturdy and lightweight; extends to 9'. Collar clamping; standard 5/8" (1.59 cm) stud.

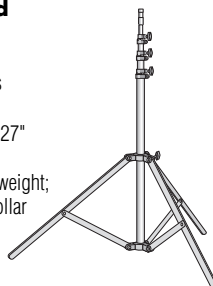

Uni TO Stand

Code: UN-55

Weight: 2.6 lbs (1.2 kg)

Size: 21.5" (54.6 cm) folded.

Maximum height: 7'11" (2.4 m)

Base diameter: 43"

New stand, based on design combination of Uni-stand & Omni-stand. More stable than Uni-stand, more compact than Omni-stand.

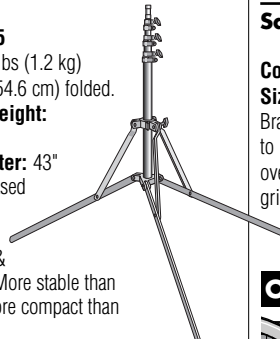

Tota-clamp

Code: T1-30

Clamps onto pipes and objects up to 1 7/8" (4.8 cm) thick. 5/8" (1.59 cm) stud locks in two positions and accepts a light. Two Flexi-shafts with Tota-flags can be attached.



Tota-mount

Code: T1-32

Hangs on doortops, Gaffer-tapes to windows and most wall surfaces to support Tota, Omni and other small lights. Folds for storage.

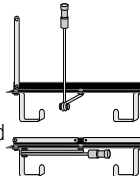

Scissor-mount (2)

Code: CM-20

Attaches small lights and accessories to grid of dropped-ceiling in offices and other areas. (Set of 2).



Lobo



Code: F1-30

Attaches Lobo Arm to top or any part of a stand to make a miniature boom. Also mounts large umbrellas, flags, etc.

Lobo Arm

Code: F1-40

22" (55.9 cm) shaft with 5/8" (1.59 cm) stud. Extends, articulates and booms small lights, reflectors, etc.

Safety Cable (3)

Code: CM-50

Size: 34" (86.4 cm)

Braided stainless-steel cable adds security to lights and accessories that are attached to overhead pipes, beams, dropped-ceiling grids, etc. (Set of 3).



Omni Adjustments

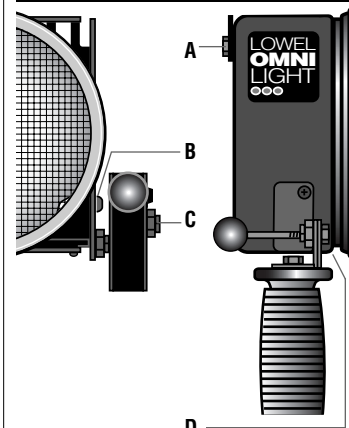

Omni has four constant-tension (torque) pivot points. All have flat spring washers to maintain proper tension and can be adjusted, if necessary, with a 7/16" wrench.

A Gel-brella bracket tension can be adjusted by the bolt attaching the bracket to the rear of the light.

B Focus "drag" can be adjusted with the nut located just in front of the stand fitting on the opposite side of the fixture.

C Tilt tension can be adjusted with the nut located on the stand fitting.

D Handle tension can be adjusted by the nut located on the handle mounting bracket.

Do not over tighten!

Lowel Omni-light Instructions

Omni-light for the New Pro

The wide focusing range of the Omni-light makes it a flexible key, fill or back-light. Adding accessories will extend its creative possibilities.

Use the focusing knob to move from Spot (narrow beam) to Flood (wide beam). Its 6:1 focus ratio (when used with supplied #1 reflector & an FTK lamp) means that the spot setting will be approximately 6 times as bright as the flood setting.



Omni is an open face (lensless) fixture.

It is capable of throwing sharp shadows. Add a diffusion glass accessory, diffusion gel with a Tota-frame, or attach an umbrella to create a softer source. Use one Omni without diffusion and another with diffusion, to create the classic "hard key & soft fill" lighting setup common in many interview & still life settings.

Use the rotating barndoors to trim unwanted output spill, (for example: to reduce risk of shadow in your shot caused by use of overhead boom microphones). Flexi-shafts & Tota-flags can also be attached for increased light control options.

Because the Omni is a tungsten-halogen source, its color temperature will be in the 3000–3200°K range, depending on lamp choice. To use Omni in locations where its output will mix with daylight (5600–6500°K), its color temperature can be converted by attaching a Dichroic Filter

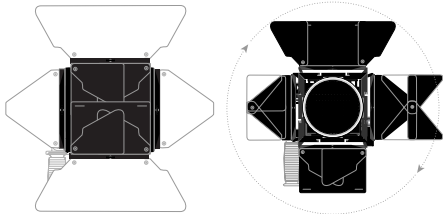

accessory, or adding day blue gels to the Tota-frame. Both will give more realistic daylight white-balancing in video or film.

To simply raise the ambient level of light in a room, point the Omni-light at a white wall or ceiling (from a safe distance of several feet or more), and focus to flood setting. Position the light so it won't be in your shot.

The Omni-light can use different wattage lamps, from 300–500W @ 120V. This increases its versatility, especially when mixing with other fixtures of different max. wattages. See the lamp chart for more information.

For special use applications, Omni can be converted in the following ways (see Accessories for more information):



Swap the power cord & lamp, then exchange to the #2 reflector for a battery powered, hand-held light at 12 or 30V.



Swap to the #3 reflector for non-focusing higher output Super-Spot. This can be useful when lighting a smaller area from a greater distance when higher output is needed.

Or use the #4 reflector for warmer color output to simulate late day sun or when lighting a pale skin complexion.

For more reduced spill, consider adding either the Omni Snoot or the Omni Narrow Snoot which allows front accessories, for further control options.

Other front accessories can help vary the quality of the light output. For example, the rotating half-scrim can allow you to reduce light output on a close subject while still

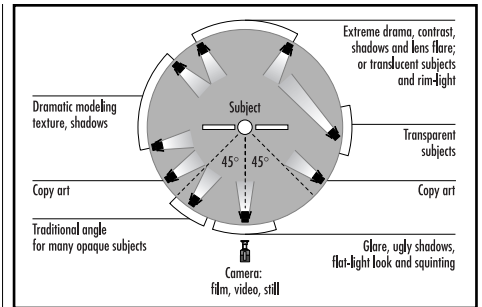

illuminating subjects further away with full output. The full scrim reduces output without the use of a dimmer which can shift the color temperature warmer as the lamp is dimmed.

The oversimplified diagram above shows some of the ramifications of positioning lights for different subject types & lighting effects. This diagram is only useful as a starting point for new pros. All subjects & scenes are different and make different demands upon lighting. The height of the lights & camera, and the subjects angles & reflectivity must be considered.

When finished setting multiple lights, it's a good idea to check the effect of each light by powering them all down & looking at your set with one light on at a time. This will help you better understand the components of lighting and how each fixture contributes to the final image.

These are just some starting suggestions.

For additional introductory information, see the Resources section of the complete Lowel catalog. For an in-depth understanding of the creative decisions involved in the art of lighting, we suggest Ross Lowell's acclaimed book, *Matters of Light & Depth*, available from many of our dealers.

Example Setups using Omni-light

Setup 1

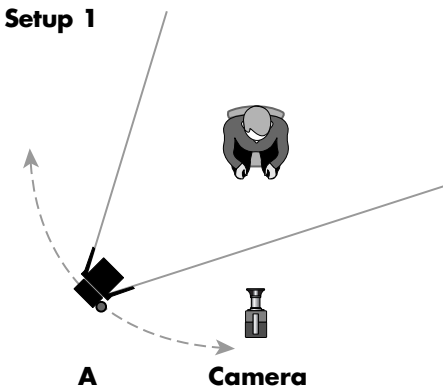

These 3 setups show some ways the Omni can be used; alone, with Tota-brella, or with diffusion, in a small lighting setup. Position of the lights and distance to the subject can be varied for different creative results. Varying the distance of either light from the subject will vary the contrast ratio between Key & Fill lights. **Tip:** position your subject away from walls to avoid shadows and give more a sense of depth.

Setup #1 shows single fixture use, and can be set on either side of the camera. Varying the position of the light will increase shadow & contrast on the subject.

Setup 2

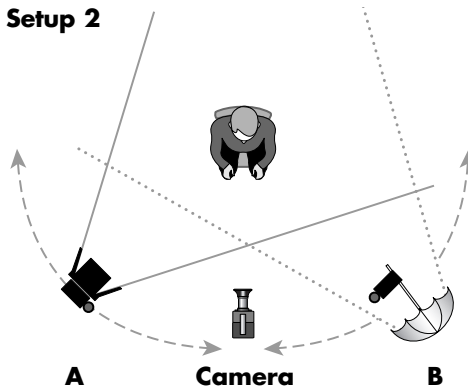

Setup #2 uses 2 Omni's, one with only barn doors, as hard key, and the other with a Tota-brella as soft fill. Vary the position of the lights, as shown. Be aware of reflection in eyeglasses or reflective surfaces.

Setup #3 uses 2 Omni's as hard key/soft fill, with a Tota to evenly light the background. An additional Omni from high up behind the subject as a back hair-light, lighting the back of the head & shoulders, will create a sense of separation from the background. Be careful to keep the light output of the back light from spilling into the camera lens which will cause lens flare.

Setup 3

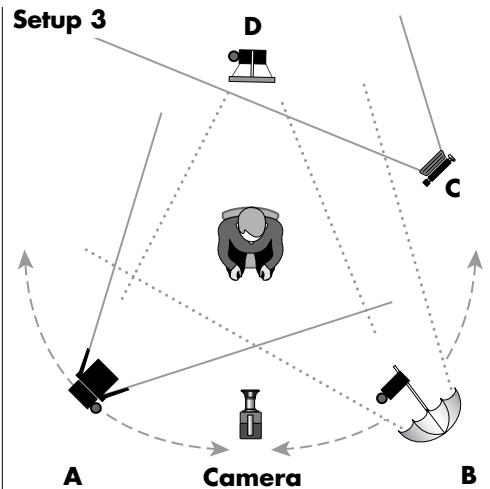

Setup Keys

- A** Key light Omni with barndoors
- B** Fill light Omni with umbrella
- C** Background Tota
- D** High back light Omni with Tota-frame & diffusion

Problems, info, repairs, etc.

Lowel equipment and kits are sold through authorized Lowel Dealers and, in some countries, Authorized Lowel Distributors. Repairs, problems, suggestions, and requests for brochures, instructions, parts lists may be handled by your authorized Lowel Dealer (Distributor) or directly with Lowel. Electrical repairs should be made only by Lowel or a qualified electrician. Lowel Omni-system, Lowel Omni-light, Lowel Tota-system and Tota-light are trademarks of Lowel-Light Manufacturing, Inc. Lowel Patent Nos.: 3852582, 4187531, version: 5.0 © Lowel-Light Mfg., Inc. 2005

Lowel-Light Manufacturing, Inc.

140 58th Street Brooklyn, NY 11220
Call: 800 334-3426 or 718 921-0600
Fax: 718 921-0303
e-mail: info@lowel.com
www.lowel.com